



VOLANTÉ V1000

GENERAL SURGERY TABLE



BRINGING
VERSATILITY
TO THE OPERATING ROOM



PRODUCT
SPECIFICATIONS

Volanté V1000 Specifications

- Sleek, streamlined stainless-steel construction
- Powered operating table with 180° rotating top for general and specialty surgery
- 1,000 lbs. maximum patient weight¹
- Full-length radiolucent top
- Offset cylindrical column for superior imaging and access
- Optional battery back-up in the event of power failure
- Hand control activates/deactivates brakes, wheels and castors for stability and steering
- Head section is removable and added to leg section for superior imaging accessibility
- Pressure-relieving mattress²

Dimensions

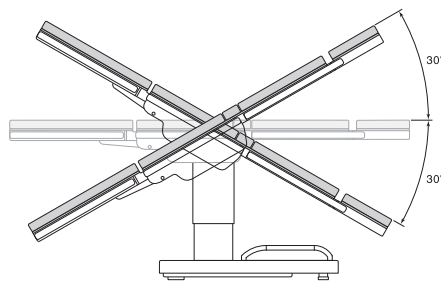
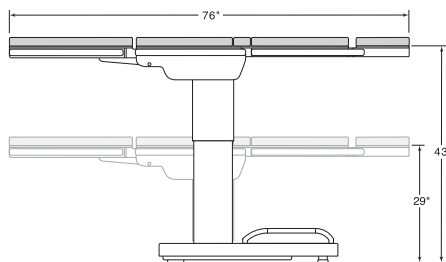

30° Trendelenburg
and Reverse Trendelenburg

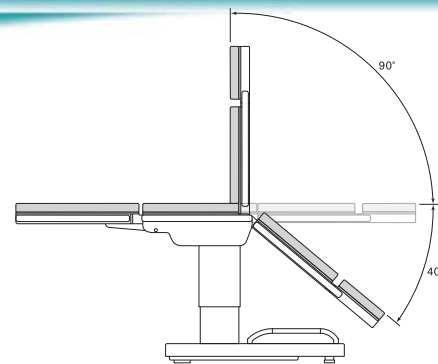

Back Up 90°
Back Down 40°

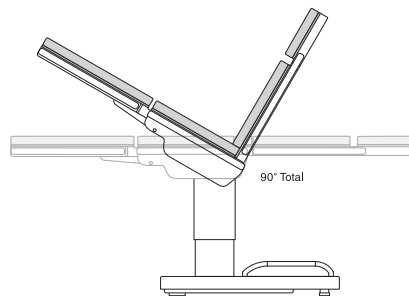

Reflex 90°

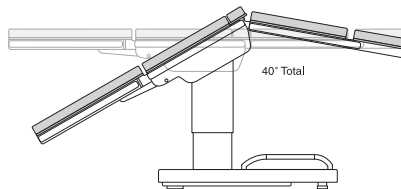

Flex 40°

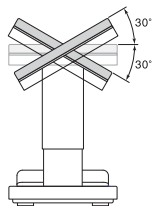

30° Lateral Tilt
Right & Left

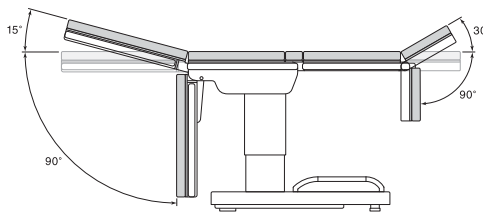

Head Up 30° Head Down 90°
Leg Up 15° Leg Down 90°

Table Top

Length:	76"
Width:	19.75"
Max. Height:	43"
Min. Height:	29"

Lift Capacity

1,000 lbs.

Articulation

800 lbs.

Lateral Tilt

30°

Trendelenburg

30°

Back Section

+ 90°
- 40°

Head Section

+ 30°
- 90°

Leg Section

+ 15°
- 90°

Table Rotation

180°

Self-Leveling Brakes

Powered

¹ See Instructions for Use (table positions and safe loading section)

² Includes 2" mattress



A member of the Medical Illumination International Group

5368 Kuhl Road • Erie, PA 16510-4703

(800) 663-1152 • (814) 899-4220

Fax: (814) 899-1410

www.nuvosurgical.com

